

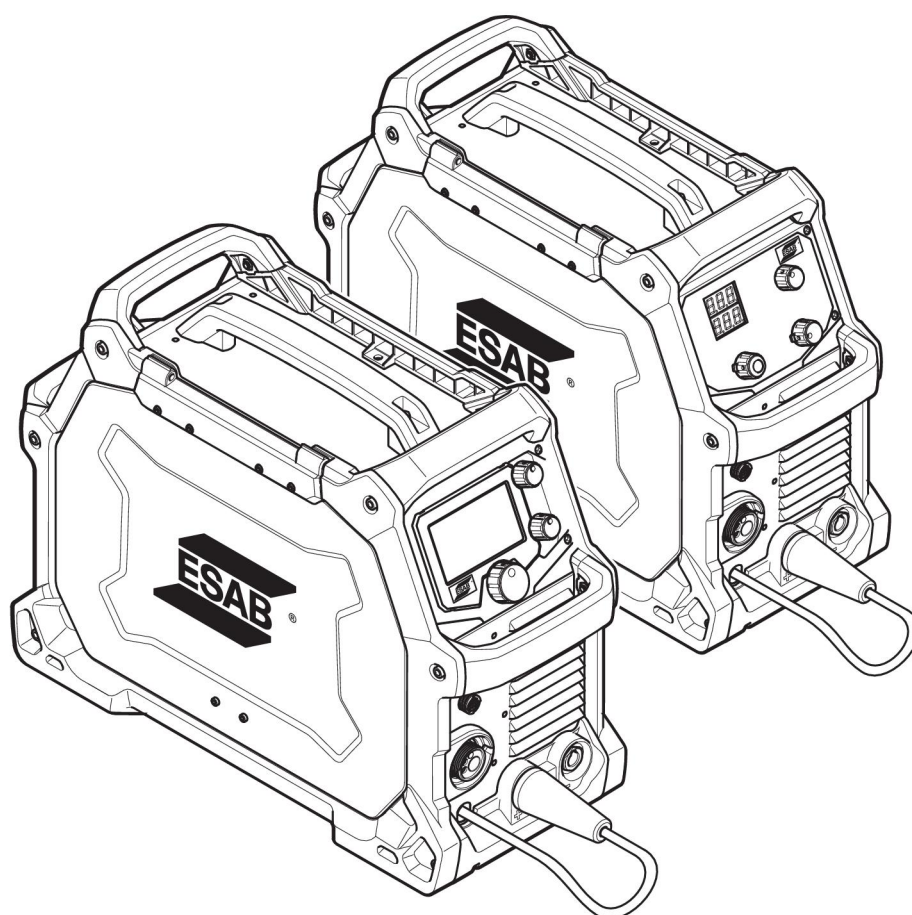

Rebel

# ***EMP 215ic, EM 215ic***



## **Instruction manual**



## EU DECLARATION OF CONFORMITY

According to  
The Low Voltage Directive 2014/35/EU, entering into force 20 April 2016  
The EMC Directive 2014/30/EU, entering into force 20 April 2016  
The RoHS Directive 2011/65/EU, entering into force 2 January 2013

**Type of equipment**

Welding power source

**Type designation**

EMP 215ic, from serial number 615 xxx xxx (2016 w/15)  
EM 215ic, from serial number 615 xxx xxx (2016 w/15)

**Brand name or trade mark**

ESAB

**Manufacturer or his authorised representative established within the EEA**

**Name, address, and telephone No:**

ESAB AB  
Lindholmsallén 9, Box 8004, SE-402 77 Göteborg, Sweden  
Phone: +46 31 50 90 00, Fax: +46 31 50 92 22

**The following harmonised standard in force within the EEA has been used in the design:**

EN 60974-1:2012, Arc Welding Equipment – Part 1: Welding Power Sources  
EN 60974-5:2013, Arc Welding Equipment – Part 5: Wire Feeders  
EN 60974-10:2014, Arc Welding Equipment – Part 10: Electromagnetic Compatibility (EMC) requirements

**Additional Information:**

Restrictive use, Class A equipment, intended for use in location other than residential

**By signing this document, the undersigned declares as manufacturer, or the manufacturer's authorised representative established within the EEA, that the equipment in question complies with the safety requirements stated above.**

**Date**

**Signature**

**Position**

Gothenburg

A handwritten signature in black ink, appearing to read "Stephen Argo". The signature is written in a cursive, flowing style.

Global Director Equipment

2016-04-20

Stephen Argo

CE 2016

<b>1</b>	<b>SAFETY</b> .....	<b>5</b>
1.1	Meaning of symbols .....	5
1.2	Safety precautions .....	5
<b>2</b>	<b>INTRODUCTION</b> .....	<b>8</b>
2.1	Equipment .....	8
<b>3</b>	<b>TECHNICAL DATA</b> .....	<b>10</b>
<b>4</b>	<b>INSTALLATION</b> .....	<b>13</b>
4.1	Location .....	13
4.2	Lifting instructions .....	13
4.3	Mains supply .....	14
4.3.1	Recommended fuse sizes and minimum cable area .....	15
<b>5</b>	<b>OPERATION</b> .....	<b>16</b>
5.1	Connections .....	17
5.2	Connection of welding and return cables .....	18
5.3	Polarity change .....	18
5.4	Inserting and replacing wire .....	19
5.5	Setting the wire feed pressure .....	21
5.6	Changing the feed/pressure rollers .....	21
5.7	Shielding gas .....	22
5.8	Duty cycle .....	23
5.9	Overheating protection .....	24
<b>6</b>	<b>CONTROL PANEL</b> .....	<b>25</b>
6.1	How to navigate - EMP 215ic .....	25
6.1.1	Main menu .....	25
6.1.2	sMIG mode .....	25
6.1.3	Manual MIG mode .....	26
6.1.4	Flux cored wire mode .....	26
6.1.5	MMA mode .....	26
6.1.6	LIFT-TIG mode .....	26
6.1.7	Settings .....	27
6.1.8	User manual information .....	27
6.1.9	Icon reference guide .....	27
6.2	How to navigate - EM 215ic .....	30
6.2.1	Symbol reference EM 215ic .....	30
<b>7</b>	<b>MAINTENANCE</b> .....	<b>31</b>
7.1	Routine maintenance .....	31
7.2	Power source and wire feeder maintenance .....	31
7.3	Torch and liner maintenance .....	32
<b>8</b>	<b>TROUBLESHOOTING</b> .....	<b>33</b>
<b>9</b>	<b>ORDERING SPARE PARTS</b> .....	<b>35</b>

TABLE OF CONTENTS

---

**DIAGRAM ..... 36**  
**ORDERING NUMBERS ..... 37**  
**WEAR PARTS..... 38**  
**ACCESSORIES ..... 40**  
**REPLACEMENTS PARTS..... 41**

# 1 SAFETY

## 1.1 Meaning of symbols

As used throughout this manual: Means Attention! Be Alert!

**DANGER!**

Means immediate hazards which, if not avoided, will result in immediate, serious personal injury or loss of life.

**WARNING!**

Means potential hazards which could result in personal injury or loss of life.

**CAUTION!**

Means hazards which could result in minor personal injury.

**WARNING!**

Before use, read and understand the instruction manual and follow all labels, employer's safety practices and Safety Data Sheets (SDSs).



## 1.2 Safety precautions

Users of ESAB equipment have the ultimate responsibility for ensuring that anyone who works on or near the equipment observes all the relevant safety precautions. Safety precautions must meet the requirements that apply to this type of equipment. The following recommendations should be observed in addition to the standard regulations that apply to the workplace.

All work must be carried out by trained personnel well-acquainted with the operation of the equipment. Incorrect operation of the equipment may lead to hazardous situations which can result in injury to the operator and damage to the equipment.

1. Anyone who uses the equipment must be familiar with:
  - its operation
  - location of emergency stops
  - its function
  - relevant safety precautions
  - welding and cutting or other applicable operation of the equipment
2. The operator must ensure that:
  - no unauthorised person is stationed within the working area of the equipment when it is started up
  - no-one is unprotected when the arc is struck or work is started with the equipment
3. The workplace must:
  - be suitable for the purpose
  - be free from drafts

4. Personal safety equipment:
  - Always wear recommended personal safety equipment, such as safety glasses, flame-proof clothing, safety gloves
  - Do not wear loose-fitting items, such as scarves, bracelets, rings, etc., which could become trapped or cause burns
5. General precautions:
  - Make sure the return cable is connected securely
  - Work on high voltage equipment **may only be carried out by a qualified electrician**
  - Appropriate fire extinguishing equipment must be clearly marked and close at hand
  - Lubrication and maintenance must **not** be carried out on the equipment during operation

**WARNING!**

Arc welding and cutting can be injurious to yourself and others. Take precautions when welding and cutting.

**ELECTRIC SHOCK - Can kill**

- Install and ground the unit in accordance with instruction manual.
- Do not touch live electrical parts or electrodes with bare skin, wet gloves or wet clothing.
- Insulate yourself from work and ground.
- Ensure your working position is safe

**ELECTRIC AND MAGNETIC FIELDS - Can be dangerous to health**

- Welders having pacemakers should consult their physician before welding. EMF may interfere with some pacemakers.
- Exposure to EMF may have other health effects which are unknown.
- Welders should use the following procedures to minimize exposure to EMF:
  - Route the electrode and work cables together on the same side of your body. Secure them with tape when possible. Do not place your body between the torch and work cables. Never coil the torch or work cable around your body. Keep welding power source and cables as far away from your body as possible.
  - Connect the work cable to the workpiece as close as possible to the area being welded.

**FUMES AND GASES - Can be dangerous to health**

- Keep your head out of the fumes.
- Use ventilation, extraction at the arc, or both, to take fumes and gases away from your breathing zone and the general area.

**ARC RAYS - Can injure eyes and burn skin**

- Protect your eyes and body. Use the correct welding screen and filter lens and wear protective clothing.
- Protect bystanders with suitable screens or curtains.

**NOISE - Excessive noise can damage hearing**

Protect your ears. Use earmuffs or other hearing protection.

**MOVING PARTS - Can cause injuries**



- Keep all doors, panels and covers closed and securely in place. Have only qualified people remove covers for maintenance and troubleshooting as necessary. Reinstall panels or covers and close doors when service is finished and before starting engine.



- Stop engine before installing or connecting unit.
- Keep hands, hair, loose clothing and tools away from moving parts.

**FIRE HAZARD**



- Sparks (spatter) can cause fire. Make sure that there are no inflammable materials nearby.
- Do not use on closed containers.

**MALFUNCTION - Call for expert assistance in the event of malfunction.**

**PROTECT YOURSELF AND OTHERS!**



**CAUTION!**

This product is solely intended for arc welding.



**WARNING!**

Do not use the power source for thawing frozen pipes.



**CAUTION!**

Class A equipment is not intended for use in residential locations where the electrical power is provided by the public low-voltage supply system. There may be potential difficulties in ensuring electromagnetic compatibility of class A equipment in those locations, due to conducted as well as radiated disturbances.

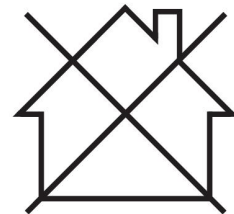

**NOTE!**

**Dispose of electronic equipment at the recycling facility!**

In observance of European Directive 2012/19/EC on Waste Electrical and Electronic Equipment and its implementation in accordance with national law, electrical and/or electronic equipment that has reached the end of its life must be disposed of at a recycling facility.

As the person responsible for the equipment, it is your responsibility to obtain information on approved collection stations.

For further information contact the nearest ESAB dealer.

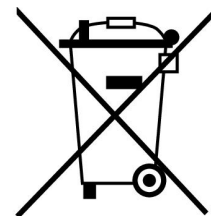

**ESAB has an assortment of welding accessories and personal protection equipment for purchase. For ordering information contact your local ESAB dealer or visit us on our website.**

## 2 INTRODUCTION

---

The ESAB EM and EMP product family is a new generation of MIG and Multi-Process (MIG/MMA/TIG) welding power sources.

The EMP 215ic and EM 215ic power sources are designed to match the needs of the light-medium fabrication user. They are tough, durable and portable, providing excellent arc performance across a variety of welding applications.

The EMP features a 11 cm (4.3 in.) colour TFT user interface display which provides quick and easy selection of weld process and parameters, suitable for both newly trained and intermediate level users. For more advanced users, a number of additional functions and features can be introduced and customized to give maximum flexibility.

Exclusive to ESAB, sMIG provides users with an excellent 'Short circuit' arc characteristic.

The EM and EMP family connects to an input power supply range between 120 V – 230 V, 1 ~ 50/60 Hz input power supplies. Input power can be supplied by mains or generator. Incorporating a PFC (Power Factor Correction) circuit significantly increases power efficiency.

Key features:

- Excellent MIG characteristics (EM)
- Excellent multi-process welding capabilities , MIG/MMA and Lift/TIG (EMP)
- Automatic recognition of input power with PFC (120 V – 230 V)
- Large 11 cm (4.3 in.) high resolution, customizable user interface (EMP)
- Rugged case design and internal hardware
- Portable, single person lift and carry design
- High grade cast aluminium wire drive system provides excellent control of drive roll geometry ensuring smooth, precise wire feeding
- Professional high grade accessories

### 2.1 Equipment

Package consists of the following:

#### EMP series

- ESAB EMP 215ic power source
- ESAB MXL 200 MIG torch, 3 m (10 ft)
- Contact tip M6 for 0.8 mm (0.030 in.) wire (qty 2)
- Contact tip M6 for 1.0 mm (0.040 in.) wire (qty 2)
- Gas hose, 4.5 m (14.8 ft), Quick connector
- MMA welding cable kit 3 m (10 ft)
- Return cable kit 3 m (10 ft)
- OK 12.50 0.8 mm (0.030 in.) × 5 kg (11 lb) bobbin
- Drive roll: 0.6 / 0.8 mm (0.023 in. / 0.030 in.) Cored, Steel and Stainless wire (installed on drive system)
- Drive roll: 0.8 / 1.0 mm (0.030 in. / 0.040 in.) Cored, Steel and Stainless wire (in accessory box)
- Guide tube 1.0 mm – 1.2 mm (0.040 in. – 0.045 in.) (installed on drive system)
- Guide tube 0.6 mm – 0.8 mm (0.023 in. – 0.030 in.) (in accessory box)
- Mains cable 3 m (10 ft), fixed with plug
- Safety manual
- USB with Operator's Manual
- Material thickness guide



**EM series**

- ESAB EM 215ic power source
- ESAB MXL 200 MIG torch, 3 m (10 ft)
- Contact tip M6 for 0.8 mm (0.030 in.) wire (qty 2)
- Contact tip M6 for 1.0 mm (0.040 in.) wire (qty 2)
- Gas hose, 4.5 m (14.8 ft), Quick connector
- Return cable kit 3 m (10 ft)
- OK 12.50 0.8 mm (0.030 in.) × 5 kg (11 lb) bobbin
- Drive roll: 0.6 / 0.8 mm (0.023 in. / 0.030 in.) Cored, Steel and Stainless wire (installed on drive system)
- Drive roll: 0.8 / 1.0 mm (0.030 in. / 0.040 in.) Cored, Steel and Stainless wire (in accessory box)
- Guide tube 1.0 mm – 1.2 mm (0.040 in. – 0.045 in.) (installed on drive system)
- Guide tube 0.6 mm – 0.8 mm (0.023 in. – 0.030 in.) (in accessory box)
- Mains cable 3 m (10 ft), fixed with plug
- Safety manual
- USB with Operator's Manual
- Material thickness guide

### 3 TECHNICAL DATA

	<b>EMP 215ic</b>	
<b>Voltage</b>	230 V, 1 ~ 50/60 Hz	120 V, 1 ~ 50/60 Hz
<b>Primary current</b>		
$I_{\max}$ . GMAW - MIG	30 A	Breaker 20 A: 28.6 A Breaker 15 A: 20.3 A
$I_{\max}$ . GTAW - TIG	19 A	Breaker 15 A: 20.8 A
$I_{\max}$ . SMAW - MMA	25 A	Breaker 15 A: 20.8 A
$I_{\text{eff}}$ . GMAW - MIG	14 A	Breaker 20 A: 13 A Breaker 15 A: 13 A
$I_{\text{eff}}$ . GTAW - TIG	10 A	Breaker 15 A: 14.7 A
$I_{\text{eff}}$ . SMAW - MMA	13 A	Breaker 15 A: 14.7 A
<b>Permissible load at GMAW - MIG</b>		
100% duty cycle	110 A / 19.5 V	Breaker 20 A: 90 A / 18.5 V Breaker 15 A: 75 A / 17.75 V
60% duty cycle	125 A / 20.25 V	Breaker 20 A: 110 A / 19.5 V Breaker 15 A: 90 A / 18.5 V
40% duty cycle	150 A / 21.5 V	Breaker 15 A: 100 A / 19 V
25% duty cycle	205 A / 24.25 V	-
20% duty cycle	-	Breaker 20 A: 130 A / 20.5 V
<b>Setting range (DC)</b>	15 A / 14.75 V – 230 A / 25.5 V	15 A / 14.75 V – 130 A / 20.5 V
<b>Permissible load at GTAW - TIG</b>		
100% duty cycle	110 A / 14.4 V	100 A / 14 V
60% duty cycle	125 A / 15 V	120 A / 14.8 V
40% duty cycle	-	130 A / 15.2 V
30% duty cycle	180 A / 17.2 V	-
<b>Setting range (DC)</b>	5 A / 10.2 V – 200 A / 18 V	5 A / 10.2 V – 150 A / 16 V
<b>Permissible load at SMAW - MMA</b>		
100% duty cycle	100 A / 24 V	65 A / 22.6 V
60% duty cycle	125 A / 25 V	80 A / 23.2 V
40% duty cycle	-	85A / 23.4V
25% duty cycle	180 A / 27.2 V	-
<b>Setting range (DC)</b>	16 A / 20.6 V – 180 A / 27.2 V	16 A / 20.6 V – 110 A / 24.4 V
<b>Open circuit voltage (OCV)</b>		
VRD deactivated, nominal OCV (Boost OCV)	68 V / (90 V)	68 V / (90 V)
<b>Efficiency</b>	86%	84%
<b>Power factor</b>	0.98	0.99

	<b>EMP 215ic</b>	
<b>Wire feed speed</b>	1.5–12 m/min (62–475 in./min)	1.5–12 m/min (62–475 in./min)
<b>Wire diameter</b>		
Mild steel solid wire	0.6–1.0 mm (0.023–0.040 in.)	0.6–1.0 mm (0.023–0.040 in.)
Stainless steel solid wire	0.8–1.0 mm (0.030–0.040 in.)	0.9–1.0 mm (0.035–0.040 in.)
Flux cored wire	0.8–1.1 mm (0.030–0.045 in.)	0.8–1.1 mm (0.030–0.045 in.)
Aluminium	0.8–1.2 mm (0.030–3/64 in.)	0.8–1.2 mm (0.030–3/64 in.)
<b>Bobbin size</b>	Ø 100–200 mm (4–8 in.)	Ø 100–200 mm (4–8 in.)
<b>Dimensions l×w×h</b>	548 × 229 × 406 mm (23.0 × 9.0 × 16.0 in.)	548 × 229 × 406 mm (23.0 × 9.0 × 16.0 in.)
<b>Weight</b>	18.2 kg (40 lb)	18.2 kg (40 lb)
<b>Operating temperature</b>	-10 to +40 °C (-14 to +104 °F)	-10 to +40 °C (-14 to +104 °F)
<b>Enclosure class</b>	IP23S	IP23S
<b>Application classification</b>	<b>S</b>	<b>S</b>

	<b>EM 215ic</b>	
<b>Voltage</b>	230 V, 1 ~ 50/60 Hz	120 V, 1 ~ 50/60 Hz
<b>Primary current</b>		
$I_{max}$ . GMAW - MIG	30 A (27.6 A at 25% duty cycle)	Breaker 20 A: 28.6 A Breaker 15 A: 20.3 A
$I_{eff}$ . GMAW - MIG	14 A	Breaker 15 A: 14.6 A Breaker 20 A: 18.0 A
<b>Permissible load at GMAW - MIG</b>		
100% duty cycle	110 A / 19.5 V	Breaker 15 A: 75 A / 17.75 V Breaker 20 A: 90 A / 18.5 V
60% duty cycle	125 A / 20.25 V	Breaker 15 A: 90 A / 18.5 V Breaker 20 A: 110 A / 19.5 V
40% duty cycle	150 A / 21.5 V	Breaker 15 A: 100 A / 19 V
25% duty cycle	205 A / 24.25 V	-
20% duty cycle	-	Breaker 20 A: 130 A / 20.5 V
<b>Setting range (DC)</b>	15 A / 14.75 V – 235 A / 26.0 V	15 A / 14.75 V – 130 A / 20.5 V
<b>Open circuit voltage (OCV)</b>		
VRD deactivated	68 V	68 V
VRD activated	35 V	35 V
<b>Efficiency</b>	86%	84%
<b>Power factor</b>	0.98	0.99
<b>Wire feed speed</b>	2–12.1 m/min (80–475 in./min)	2–12.1 m/min (80–475 in./min)
<b>Wire diameter</b>		
Mild steel solid wire	0.6–0.9 mm (0.023–0.035 in.)	0.6–0.9 mm (0.023–0.035 in.)

	<b>EM 215ic</b>	
Stainless steel solid wire	0.8–0.9 mm (0.030–0.035 in.)	0.8–0.9 mm (0.030–0.035 in.)
Flux cored wire	0.8–1.1 mm (0.030–0.045 in.)	0.8–1.1 mm (0.030–0.045 in.)
Aluminium	0.8–1.2 mm (0.030–3/64 in.)	0.8–1.2 mm (0.030–3/64 in.)
<b>Bobbin size</b>	Ø 100–200 mm (4 in.–8 in.)	Ø 100–200 mm (4 in.–8 in.)
<b>Dimensions l×w×h</b>	548 × 229 × 406 mm (23.0 × 9.0 × 16.0 in.)	548 × 229 × 406 mm (23.0 × 9.0 × 16.0 in.)
<b>Weight</b>	18.2 kg (40 lb)	18.2 kg (40 lb)
<b>Operating temperature</b>	-10 to +40 °C (-14 to +104 °F)	-10 to +40 °C (-14 to +104 °F)
<b>Enclosure class</b>	IP23S	IP23S
<b>Application classification</b>	<b>S</b>	<b>S</b>

### Duty cycle

The duty cycle refers to the time as a percentage of a ten-minute period that you can weld at a certain current without overheating. The duty cycle is valid for 40°C / 104°F.

For more information see section "Duty cycle" in the OPERATION chapter.

### Enclosure class

The **IP** code indicates the enclosure class, i.e. the degree of protection against penetration by solid objects or water.

Equipment marked **IP 23S** is intended for indoor and outdoor use; however, should not be operated in precipitation.

### Application class

The symbol **S** indicates that the power source is designed for use in areas with increased electrical hazard.

## 4 INSTALLATION

The installation must be carried out by a professional.



### CAUTION!

This product is intended for industrial use. In a domestic environment this product may cause radio interference. It is the user's responsibility to take adequate precautions.

### 4.1 Location

Position the power source so that its cooling air inlets and outlets are not obstructed.

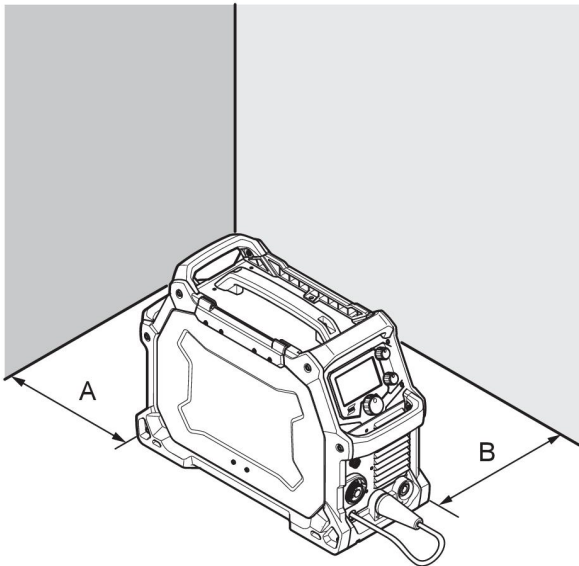

A. 100 mm (4 in.)

B. 100 mm (4 in.)

### 4.2 Lifting instructions

The power source can be lifted using any of the handles.

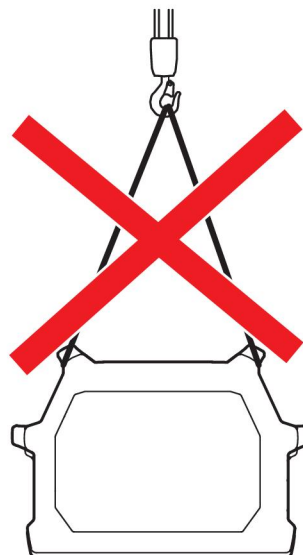
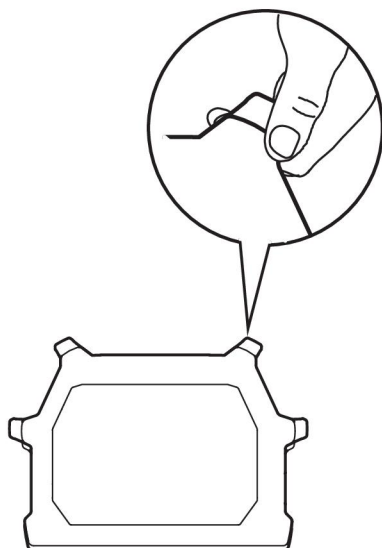

**WARNING!**

Secure the equipment - particularly if the ground is uneven or sloping.

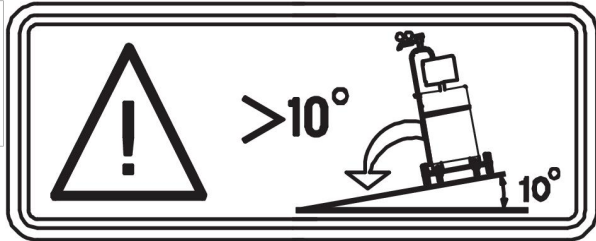

### 4.3 Mains supply

**NOTE!****Mains supply requirements**

This equipment complies with IEC 61000-3-12 provided that the short-circuit power is greater than or equal to  $S_{scmin}$  at the interface point between the user's supply and the public system. It is the responsibility of the installer or user of the equipment to ensure, by consultation with the distribution network operator if necessary, that the equipment is connected only to a supply with a short-circuit power greater than or equal to  $S_{scmin}$ . Refer to the technical data in the TECHNICAL DATA chapter.

The supply voltage should be 230 V AC  $\pm 10\%$  or 120 V  $\pm 10\%$ . Too low supply voltage may cause poor welding performance. Too high welding supply voltage will cause components to overheat and possibly fail. Contact the local electric utility for information about the type of electrical service available, how proper connections should be made, and inspection required.

The Welding power source must be:

- Correctly installed, if necessary, by a qualified electrician.
- Correctly earthed (electrically) in accordance with local regulations.
- Connected to the correct size power point and fuse as table below.

**NOTE!**

Use the welding power source in accordance with the relevant national regulations.

**CAUTION!**

Disconnect input power and secure employing 'Lock-out' / 'Tagging' procedures. Ensure input power line disconnect switch is locked (lock-out/Tagging) in the 'Open' position BEFORE removing input power fuses. Connection/Disconnect should be carried out by competent persons.

1. Rating plate with supply connection data

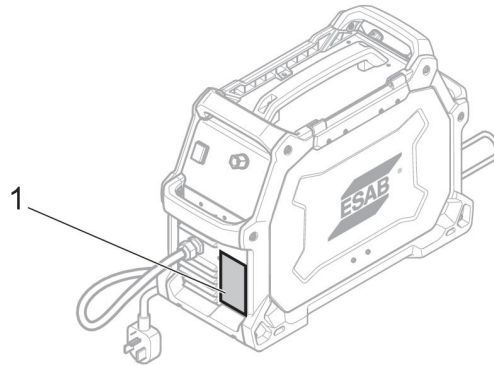

#### 4.3.1 Recommended fuse sizes and minimum cable area



**WARNING!**

An electrical shock or fire hazard is probable if the following electrical service guide recommendations are not followed. These recommendations are for a dedicated branch circuit sized for the rated output and duty cycle of the welding power source.

	<b>120 – 230 V, 1 ~ 50/60 Hz</b>	
	<b>230 V AC</b>	<b>120 V AC</b>
Supply voltage		
Input current at maximum output	30 A	30 A
Maximum recommended fuse* or circuit breaker rating	30 A	30 A
*Time delay fuse		
Maximum recommended fuse or circuit breaker rating	50 A	50 A
Minimum recommended cord size	2.5 mm <sup>2</sup> (13 AWG)	2.5 mm <sup>2</sup> (13 AWG)
Maximum recommended extension cord length	15 m (50 ft)	15 m (50 ft)
Minimum recommended grounding conductor size	2.5 mm <sup>2</sup> (13 AWG)	2.5 mm <sup>2</sup> (13 AWG)

#### Supply from power generators

The power source can be supplied from different types of generators. However, some generators may not provide sufficient power for the welding power source to operate correctly. Generators with Automatic Voltage Regulation (AVR) or with equivalent or better type of regulation, with rated power 8 kW, are recommended.

## 5 OPERATION

General safety regulations for handling the equipment can be found in the "SAFETY PRECAUTIONS" chapter of this manual. Read it through before you start using the equipment!



### NOTE!

When moving the equipment use intended handle. Never pull on the cables.



### WARNING!

Rotating parts can cause injury, take great care.



### WARNING!

Electric shock! Do not touch the workpiece or the welding head during operation!



### WARNING!

Assure that the side covers are closed during operation.



### WARNING!

Tighten the bobbin locking nut in order to prevent it from sliding off the hub.

100 mm (4 in.)

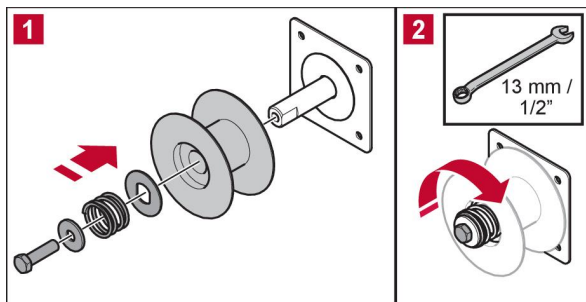

200 mm (8 in.)

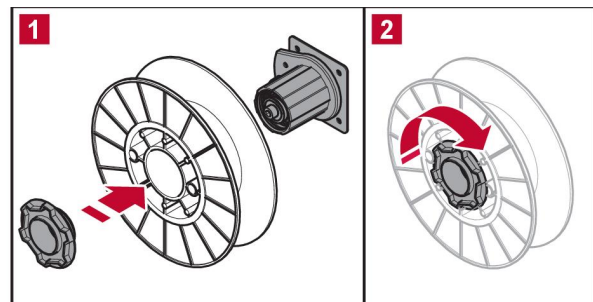



## 5.1 Connections

Front and rear:

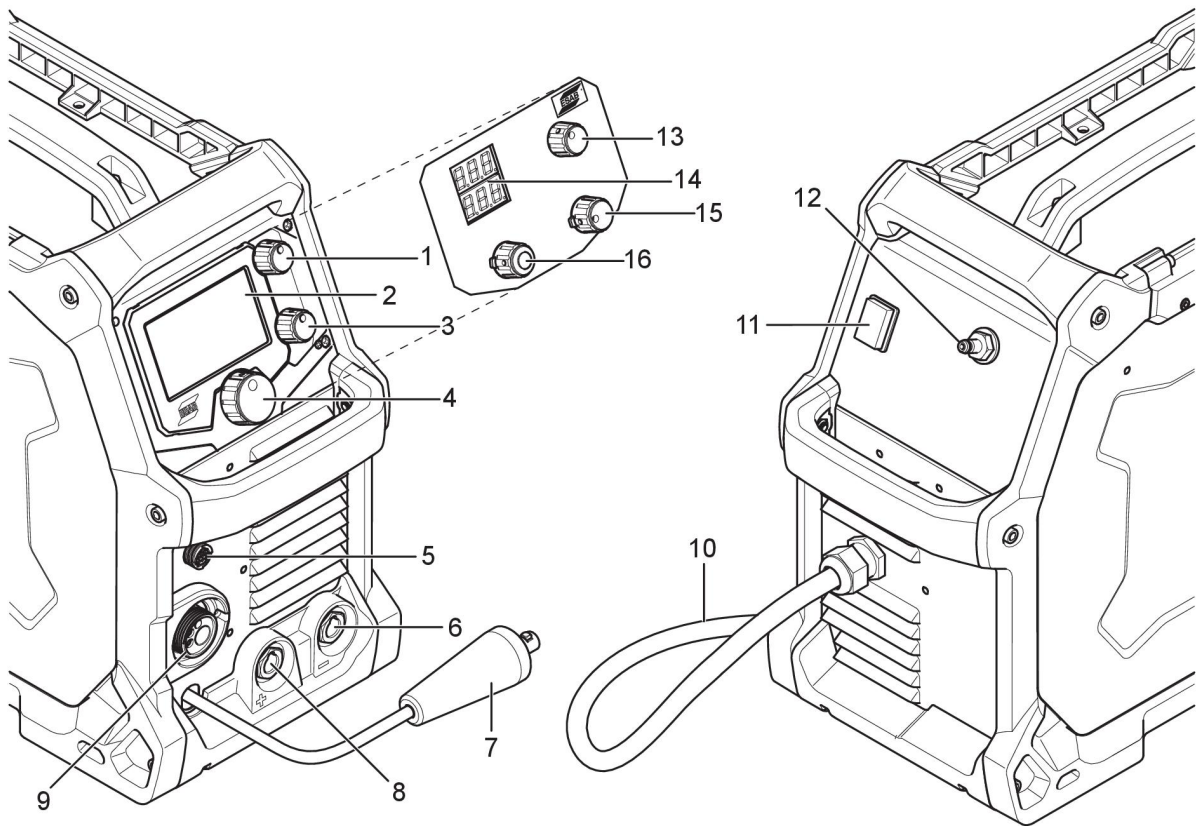

- |   |   |
|---|---|
| <ul style="list-style-type: none"> <li>1. Knob for current or wire feed speed selection (EMP)</li> <li>2. Display (EMP)</li> <li>3. Knob for voltage selection (EMP)</li> <li>4. Main knob for menu navigation (EMP)</li> <li>5. Torch/Remote control connection</li> <li>6. Negative output [-]</li> <li>7. Polarity changeover cable</li> <li>8. Positive output [+]</li> </ul> | <ul style="list-style-type: none"> <li>9. Euro torch connection</li> <li>10. Mains cable</li> <li>11. Mains supply switch ON/OFF</li> <li>12. Gas valve inlet female</li> <li>13. Knob for voltage selection (EM)</li> <li>14. Display - Volt/Ampere (EM)</li> <li>15. Knob for plate thickness or wire feed speed (EM)</li> <li>16. Knob for process selection (EM)</li> </ul> |
|---|---|

### Drive system diagram

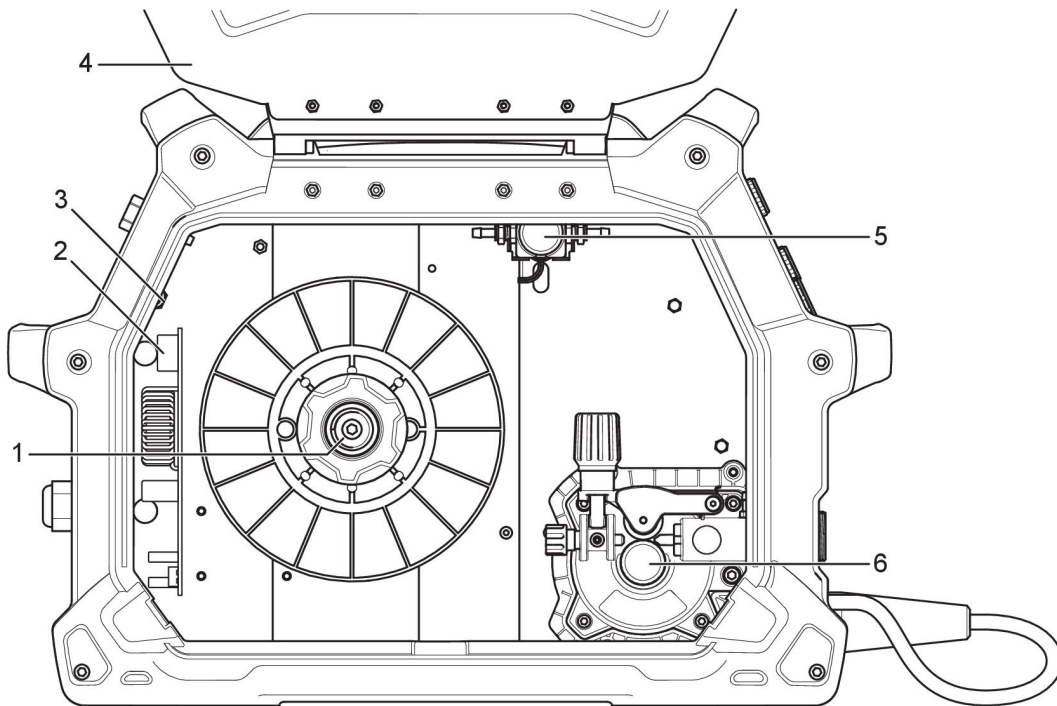

- |                    |                        |
|--------------------|------------------------|
| 1. Bobbin hub      | 4. Opening side cover  |
| 2. EMC filter      | 5. Gas valve           |
| 3. Circuit breaker | 6. Wire feed mechanism |

## 5.2 Connection of welding and return cables

The power source has two outputs for connecting welding and return cables (see illustration Front and rear), a negative [-] terminal (6) and a positive [+] terminal (8).

For MIG/MMA process the output to which the welding cable is connected depends on the type of electrode, please refer to electrode packaging for information relating to the correct electrode polarity. Connect the return cable to the remaining welding terminal on the power source. Secure the return cable's contact clamp to the work piece and ensure that there is good contact.

For TIG process (requires optional TIG accessories), connect the TIG torch power cable to the negative [-] terminal (6), see front illustration. Connect gas inlet nut to a regulated shielding gas supply. Connect the work return lead to the positive [+] terminal (8) see illustration Front and rear.

## 5.3 Polarity change

The power source is delivered with the polarity changeover cable connected to the positive terminal. Some wires, e.g. self-shielded cored wires, are recommended to be welded with negative polarity. Negative polarity means that the polarity changeover cable is connected to the negative terminal and the return cable to the positive terminal. Check the recommended polarity for the welding wire you want to use.

The polarity can be changed by moving the polarity changeover cable to suit the applicable welding process.

## 5.4 Inserting and replacing wire

The EMP 215ic and EM 215ic will handle bobbin sizes of 100 mm (4 in.) and 200 mm (8 in.). See TECHNICAL DATA chapter for suitable wire dimensions for each wire type.

**WARNING!**

Do not place or point the torch near the face, hand or body as this may result in personal injury.

**WARNING!**

Risk of crushing or pinching when replacing the wire bobbin! Do **not** use safety gloves when inserting the welding wire between the feed rollers.

**NOTE!**

Make sure the correct feed/pressure rollers are used. For more information see appendix WEAR PARTS.

**NOTE!**

Remember to use the correct contact tip in the welding torch for the wire diameter used. The torch is fitted with a contact tip for 0.8 mm (0.030 in.) wire. If you use another diameter you must change the contact tip and drive roll. The wire liner fitted in the torch is recommended for welding with Fe and SS wires.

1. Open the side cover.
2. Release the pressure roller arm by pushing the tension screw toward you (1).
3. Lift the pressure roller arm up (2).
4. With the MIG welding wire feeding from the bottom of the spool pass the electrode wire through the inlet guide (3), between the rollers, through the outlet guide and into the MIG torch.
5. Re-secure the pressure roller arm and wire drive tension screw and adjust the pressure if necessary.
6. With the MIG torch lead reasonably straight, feed the wire through the MIG torch by depressing the trigger switch.
7. Close the side cover.

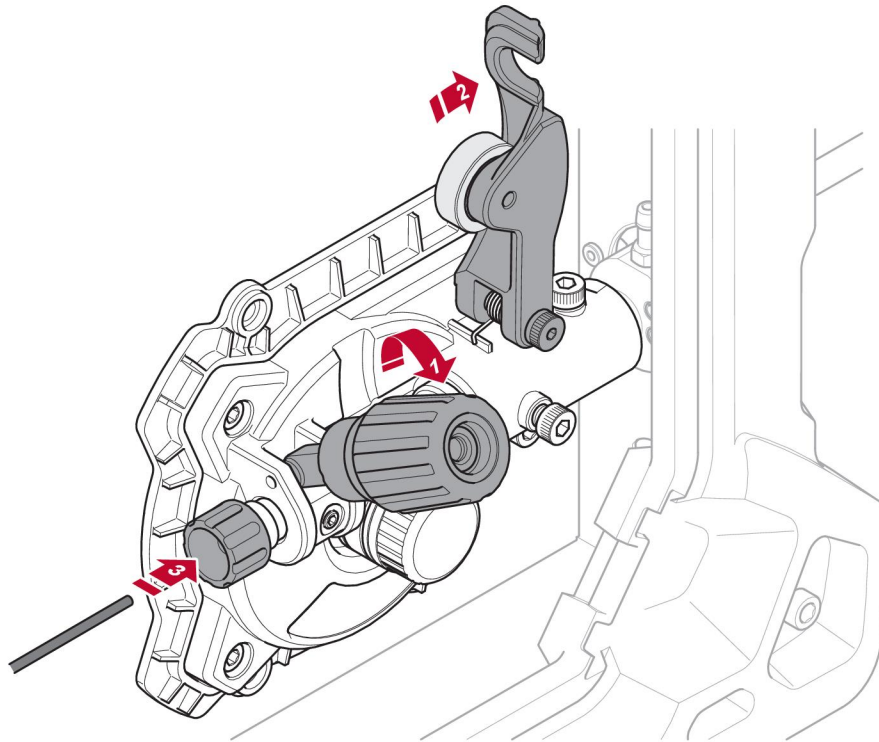

### **Welding with aluminium wire**

In order to weld aluminium using the standard supplied MXL 200 MIG torch, please refer to MIG torch instruction manual for replacing standard, steel conduit liner with Teflon conduit liner.

Please order the following accessories: 'U' groove drive roll 1.0 mm / 1.2 mm (0.040 in. / 0.045 in.) and Teflon conduit liner (PTFE liner), 3 m (10 ft). See WEAR PARTS chapter in this manual and WEAR PARTS chapter in Instruction manual for the MXL 200 for ordering number.

## 5.5 Setting the wire feed pressure

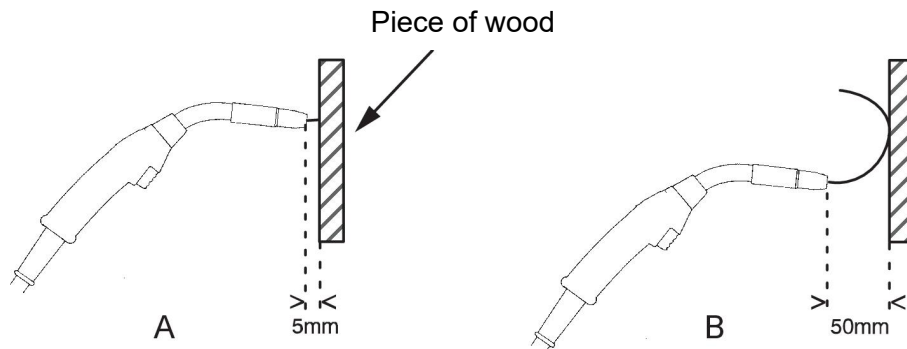

Start by making sure that the wire moves smoothly through the wire guide. Then set the pressure of the wire feeder's pressure rollers. It is important that the pressure is not too high.

To check that the feed pressure is set correctly, you can feed out the wire against an insulated object, e.g. a piece of wood.

When you hold the welding torch approximately 6 mm ( $\frac{1}{4}$  in.) from the piece of wood (illustration A) the feed rollers should slip.

If you hold the welding torch approximately 50 mm (2 in.) from the piece of wood, the wire should be fed out and bend (illustration B).

## 5.6 Changing the feed/pressure rollers

One dual groove feed roller is supplied as standard. Change the feed roller to match the filler metal.



### NOTE!

Be sure not to lose the key that is located on the drive motor shaft. This key must align with drive roll slot for proper operation.

1. Open the side cover.
2. Remove the feed roll retaining screw by turning it in counter-clockwise direction.
3. Change the feed roll.
4. Tighten the feed roll retaining screw by turning it in clockwise position.
5. Close the side cover.



### NOTE!

The visual wire stamp designates the wire diameter groove in use.

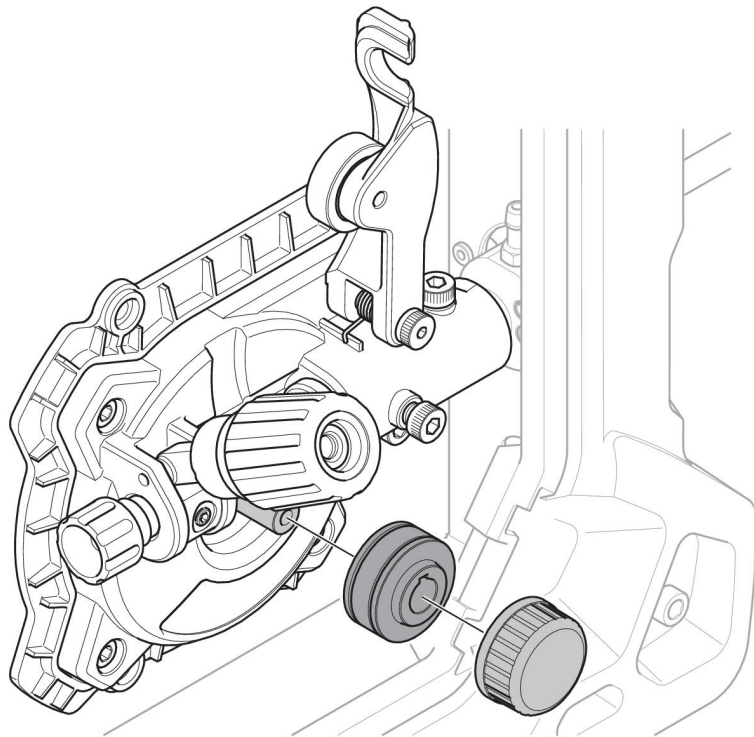
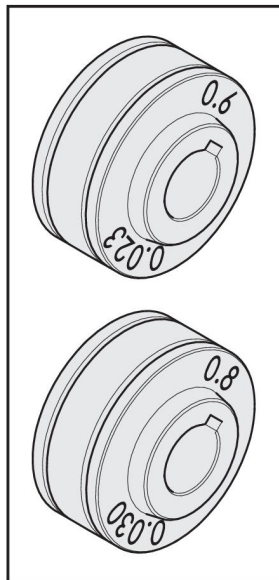

## 5.7 Shielding gas

The choice of suitable shielding gas depends on the material. Typically mild steel is welded with mixed gas (Ar + CO<sub>2</sub>) or 100% carbon dioxide (CO<sub>2</sub>). Stainless Steel can be welded with mixed gas (Ar + CO<sub>2</sub>) or Trimix (He + Ar + CO<sub>2</sub>). Aluminium and silicon bronze use pure argon gas (Ar). In the sMIG mode (see section "sMIG mode" in the CONTROL PANEL chapter) the optimal welding arc with the gas you use will be automatically set.

## 5.8 Duty cycle

The EMP 215ic and EM 215ic have a welding current output of 205 A at 25% duty cycle (230 V). A self-resetting thermostat will protect the power source if the duty cycle is exceeded.

**Example:** If the power source operates at a 25% duty cycle, it will provide the rated amperage for a maximum of 2.5 minutes out of every 10 minute period. The remaining time, 7.5 minutes, the power source must be allowed to cool down.

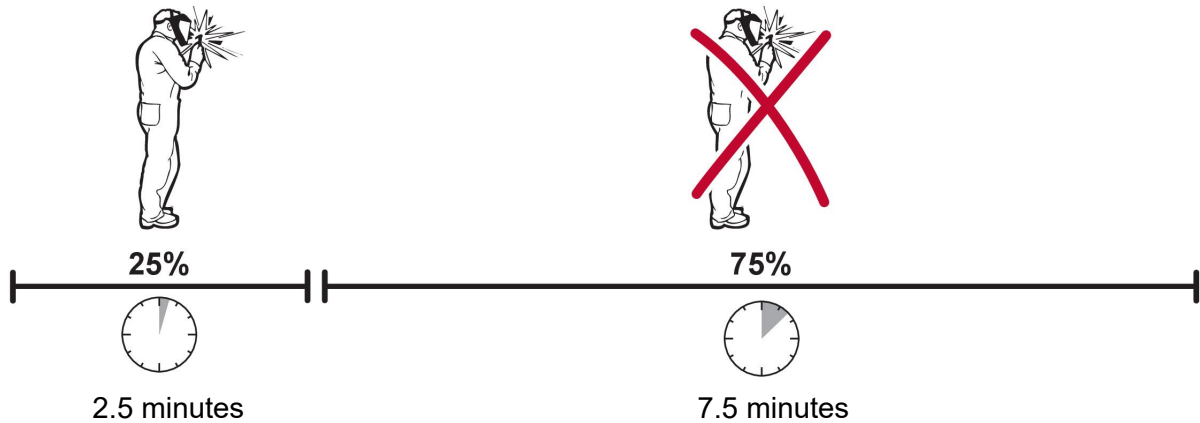

A different combination of duty cycle and welding current can be selected. Use the graphs below to determine the correct duty cycle for a given welding current.

**Duty cycle on 120 V AC**

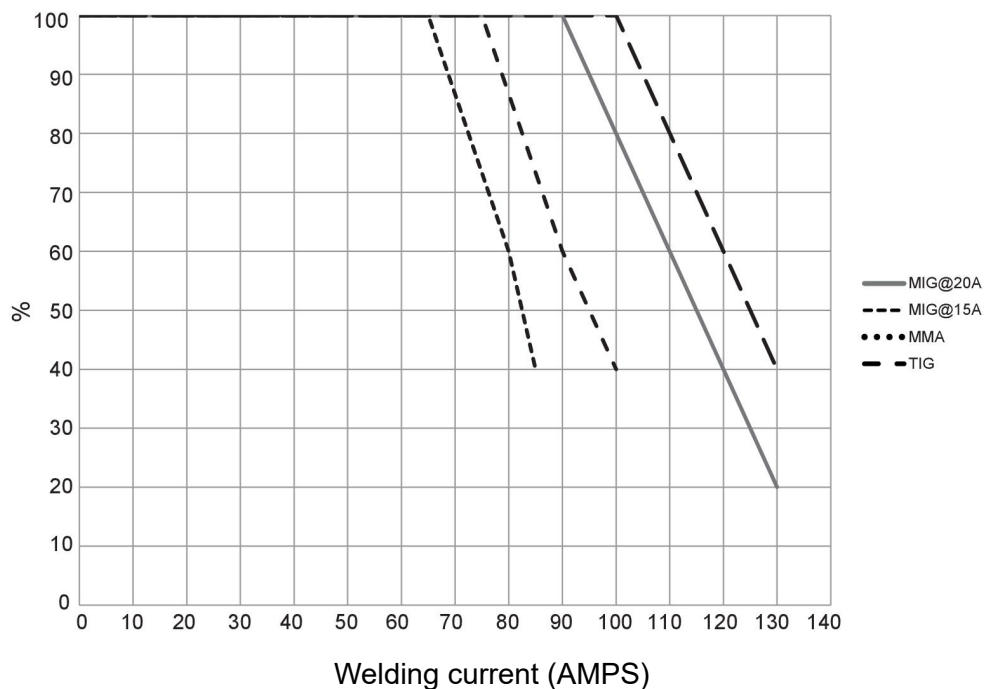

Duty cycle on 230 V AC

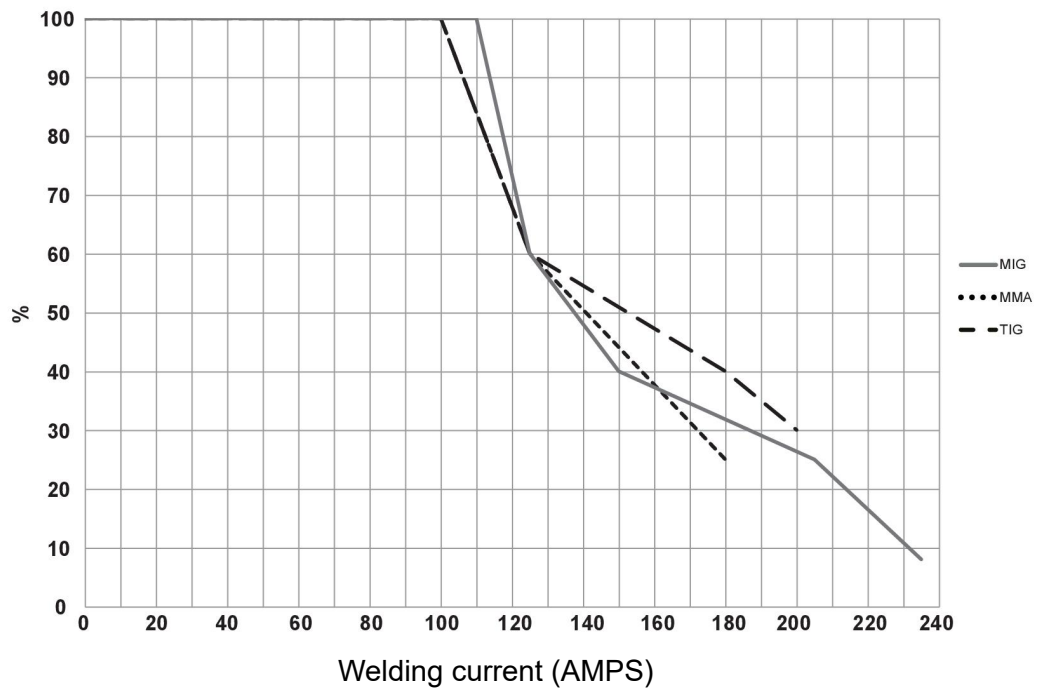

5.9 Overheating protection



The welding power source has overheating protection that operates if the internal temperature becomes too high. When this occurs the welding current is interrupted and an overheating symbol appears on the display. The overheating protection resets automatically when the temperature has returned to normal working temperature.



## 6 CONTROL PANEL

General safety regulations for handling the equipment can be found in the "SAFETY PRECAUTIONS" chapter of this manual. General information about operation can be found in the "OPERATION" chapter of this manual. Read both chapters thoroughly before you start using the equipment!

After power on has completed the main menu appears on the control panel.

### 6.1 How to navigate - EMP 215ic

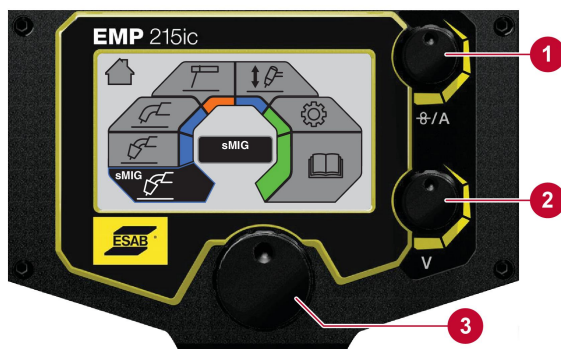

1. Current / Wire feed speed selection
2. Voltage selection
3. Menu navigation. Rotate and push to select menu option.

#### 6.1.1 Main menu

EMP 215ic

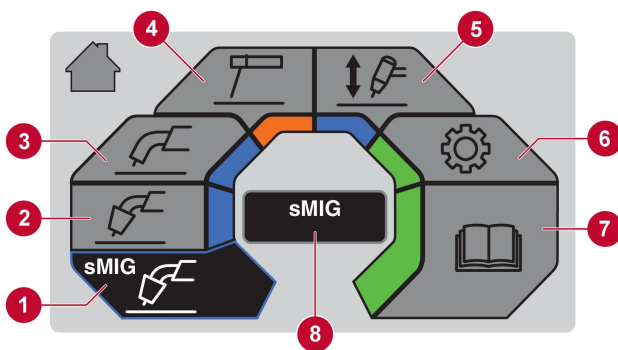

1. sMIG mode
2. Manual MIG mode
3. Flux cored wire mode
4. MMA mode
5. Lift-TIG mode
6. Settings
7. User manual information
8. Dialogue box

#### 6.1.2 sMIG mode

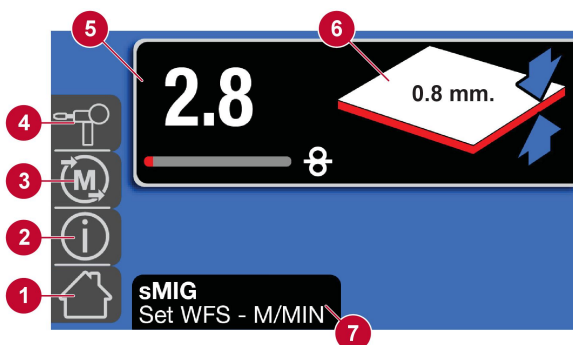

1. Home screen
2. Information
3. Memory
4. MIG/Spool gun Selection
5. Wire feed speed
6. Material thickness
7. Dialogue box

### 6.1.3 Manual MIG mode

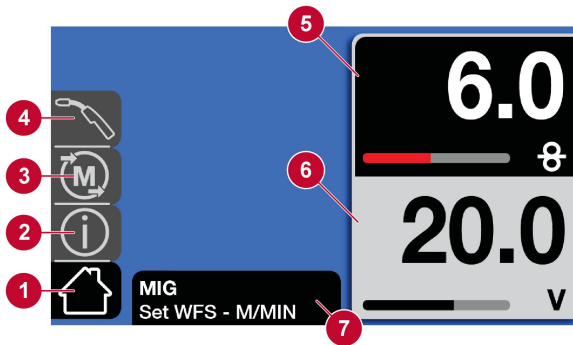

1. Home screen
2. Information
3. Memory
4. MIG/Spool gun selection
5. Wire feed speed
6. Voltage
7. Dialogue box

### 6.1.4 Flux cored wire mode

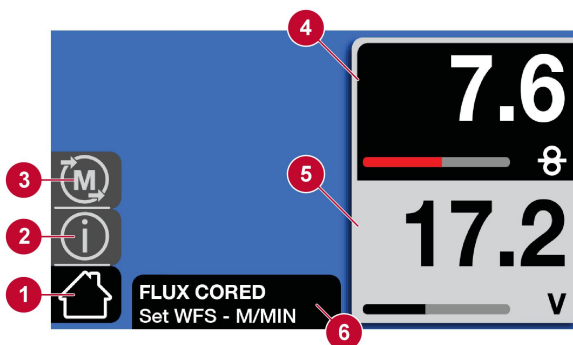

1. Home screen
2. Information
3. Memory
4. Wire feed speed
5. Voltage
6. Dialogue box

### 6.1.5 MMA mode

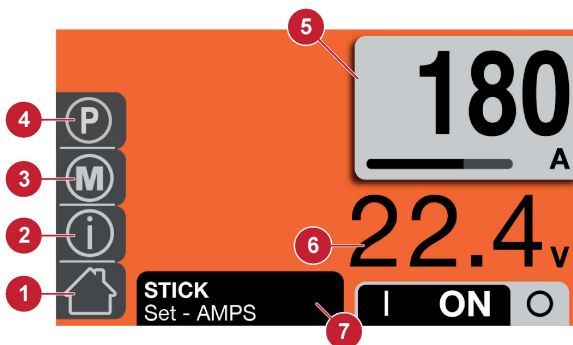

1. Home screen
2. Information
3. Memory
4. Parameter
5. Amperage
6. Voltage (OCV or Arc)
7. Dialogue box

### 6.1.6 LIFT-TIG mode

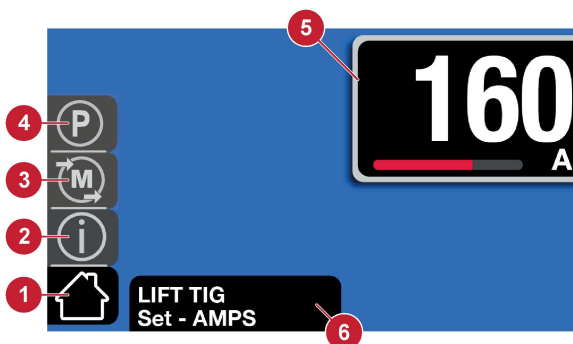

1. Home screen
2. Information
3. Memory
4. Parameter
5. Amperage
6. Dialogue box

### 6.1.7 Settings

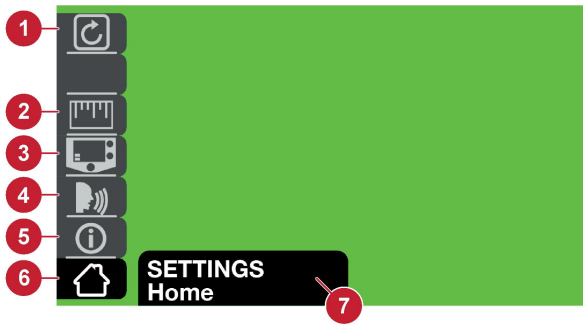





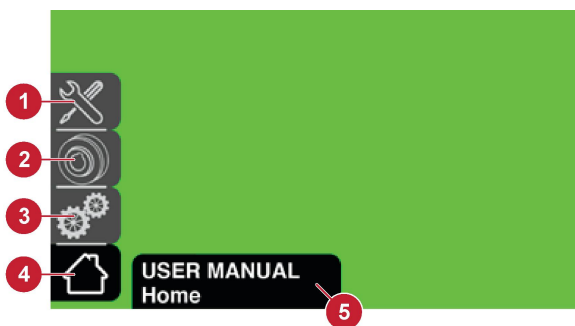







- 1. Reset mode
- 2. Inch/Metric
- 3. Basic/Advanced
- 4. Language
- 5. Information
- 6. Home screen
- 7. Dialogue box



















### 6.1.8 User manual information





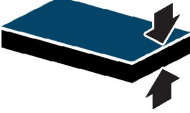





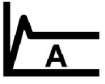

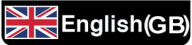

- 1. Maintenance information
- 2. Wear & Spare parts
- 3. Operation information
- 4. Home screen
- 5. Dialogue box

### 6.1.9 Icon reference guide

	Home		Spot time on/off selection
	Information		
	MIG Torch		Spot time on adjustment
	Parameters		Flux cored
	Parameters		Manual MIG
	Percent		MMA

	<b>Preflow</b> The time the shielding gas stays on before the welding arc is started		<b>Smart MIG</b>
	<b>Postflow</b> The time the shielding gas stays on after the welding arc is stopped		<b>Lift-TIG</b>
<b>S</b>	<b>Seconds</b>		<b>Saving</b> welding programs for a specific application when in the Memory Mode
	<b>Settings</b> on user manual menu		<b>Cancel</b>
	<b>Spool Gun</b> (Not all markets)		<b>Remote</b>
	<b>Settings</b>		<b>Foot control</b>
	<b>2T, Trigger On/OFF</b>		<b>Burnback</b> Adjusting the time when the voltage stays on after the wire feed is stopped to keep the wire from freezing in the weld puddle
	<b>4T, Trigger Hold/Lock</b>		<b>User manual</b> on main menu
<b>A</b>	<b>Amps</b>		<b>Plate thickness</b> at sMIG mode
	<b>Arc force</b> On stick welding-increasing amps when the arc length is shortened to reduce or eliminate the freezing of the stick electrode in the weld puddle		<b>Trim bar</b> Changing the weld bead profile from flat to convex or flat to concave
	<b>Downslope</b> Sloping the current down over a period of time at the end of the weld cycle		<b>Advanced Settings</b>

	<b>Hot start</b> The increase of amps when striking the electrode to reduce sticking		<b>Basic Settings</b>
	<b>Inductance</b> The addition of inductance into the arc characteristics to stabilize the arc and reduce spatter when in the short circuit process		<b>Diagnostics</b>
	<b>Memory</b> , able to save welding programs for a specific application		<b>Language selection</b>
	<b>Stick electrode choice</b>		<b>Unit of Measure</b>
	<b>Upslope</b> , Sloping the current up over a period of time at the beginning of the weld cycle		<b>Bead profile, concave</b>
	<b>Volts</b>		<b>Bead profile, convex</b>
	<b>Wire feed speed</b>		<b>Wire diameter</b>

## 6.2 How to navigate - EM 215ic

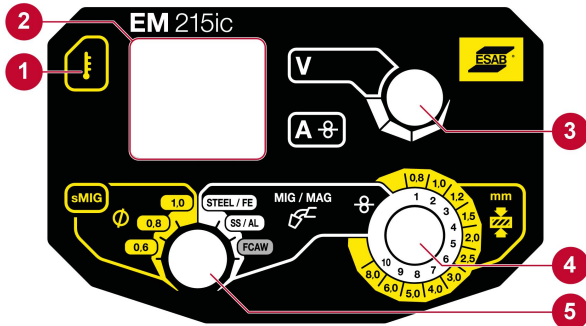

1. Over temperature indication: Symbol illuminates when product is overheated.
2. Volt/Amp display: LED displays the Volts and Amps values during welding. It holds the last used parameter.  
In sMIG "V" displays the wire diameter while idle "A" displays the set wire feed speed.
3. Voltage knob: Adjust the voltage value (in sMIG not functional).
4. Knob for plate thickness or wire feed speed: in sMIG mode (outer circle, in yellow) plate thickness can be adjusted. Wire feed speed can be adjusted when in manual MIG/MAG or flux cored (inner circle, in white).
5. Process selection knob: Enables selection between sMIG mode (left, in yellow) and manual MIG mode (right, in white).

### 6.2.1 Symbol reference EM 215ic

	<b>Overtemperature</b>		<b>Volts</b> (manual MIG mode only)
<b>sMIG</b>	<b>Smart MIG</b>		<b>Amps</b>
	<b>Wire diameter</b> (sMIG mode only)		<b>Wire feed speed</b>
<b>MANUAL</b> 	<b>Manual MIG</b>		<b>Thickness gauge</b> (sMIG mode only)

## 7 MAINTENANCE



### NOTE!

Regular maintenance is important for safe and reliable operation.



### CAUTION!

Only persons with the appropriate electrical knowledge (authorized personnel) may remove the cover of the product or carry out service, maintenance or repair work on the welding equipment.



### CAUTION!

The product is covered by manufacturer's warranty. Any attempt to carry out repair work by non-authorized service centres will invalidate the warranty.



### WARNING!

Disconnect power before performing maintenance. Maintain control and awareness of the disconnected power connections when performing work. Detect and prevent premature reconnection of the power.



### NOTE!





Perform maintenance more often during severe dusty conditions.

Before each use, make sure that:

- The torch body and torch cable and leads are not damaged.
- The contact tip on the torch is not damaged.
- The nozzle on the torch is clean and does not contain any debris.

### 7.1 Routine maintenance

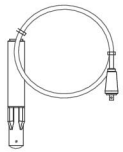
Maintenance schedule during normal conditions.

Interval	Area to maintain		
Every 3 month	 Clean or replace unreadable labels.	 Clean weld terminals.	 Check or replace weld cables.
Every 6 month	 Clean inside equipment.		

### 7.2 Power source and wire feeder maintenance

Perform a power source cleaning each time you replace a Ø100 mm (4 in.) or Ø200 mm (8 in.) wire bobbin.

## Power source and wire feeder cleaning procedure



### NOTE!

**Always wear safety gloves and spectacle during cleaning.**

1. Disconnect the power source from the input power socket.
2. Open the side panel and release the tension from the pressure roller by turning the tension screw (1) counterclockwise and then pull it toward you.
3. Remove the wire and the wire bobbin.
4. Remove the torch and use a low pressure airline, taking care not to let the wire consumable unravel, to clean the power source interior and power source air inlet and outlet.
5. Inspect if the inlet wire guide (4), outlet wire outlet (2) or the feeder roller (3) are worn and need replacement. See appendix "WEAR PARTS" for ordering numbers of parts.
6. Remove and clean the feeder roller with a soft brush. Clean the pressure roller attached to the wire feeder mechanism with a soft brush.

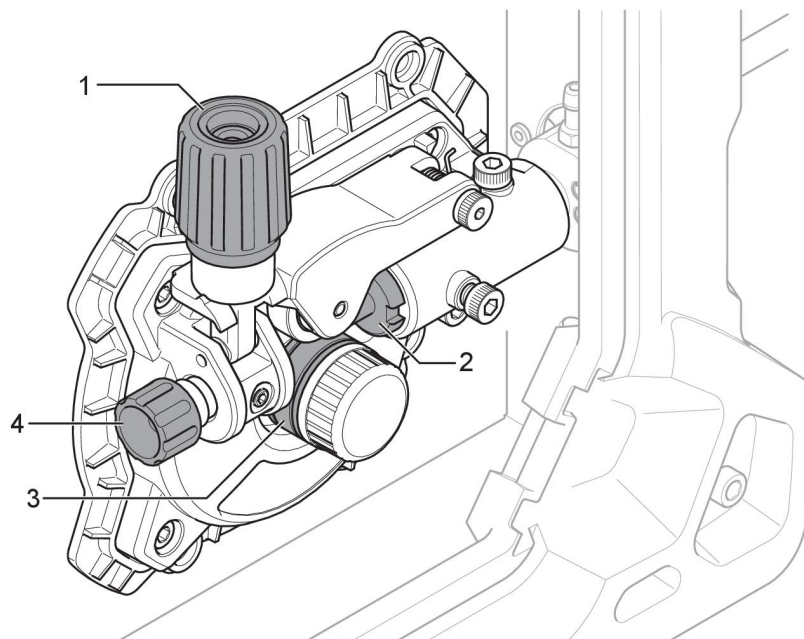

## 7.3 Torch and liner maintenance

### Torch and liner cleaning procedure

1. Disconnect the power source from the input power socket.
2. Open the side panel and release the tension from the pressure roller by turning the tension screw (1) counterclockwise and then pull it toward you.
3. Remove the wire and the wire bobbin.
4. Remove the torch from the power source.
5. Remove the liner from the torch and inspect it. Clean the liner by blowing compressed air (max. 5 bar) through the end of the liner that was mounted closest to the power source.
6. Re-install the liner.



## 8 TROUBLESHOOTING

Try these checks and inspections before sending for an authorized service technician.

Type of fault	Corrective action
Porosity within the weld metal	<ul style="list-style-type: none"> <li>• Check gas bottle is not empty.</li> <li>• Check gas regulator is not closed.</li> <li>• Check gas inlet hose for leaks or blockage.</li> <li>• Check that the correct gas is connected and the correct gas flow is used.</li> <li>• Keep the distance between the MIG torch nozzle and the work piece to a minimum.</li> <li>• Make sure the work piece is clean before welding.</li> </ul>
Wire feeding problems See appendix WEAR PARTS for correct sizes and types.	<ul style="list-style-type: none"> <li>• Make sure the wire spool brake is adjusted correctly.</li> <li>• Make sure the feed roller is correct size and not worn.</li> <li>• Make sure the correct pressure on the feed rollers is set.</li> <li>• Make sure proper direction of motion based on wire type (into the weld pool for aluminium away from the weld pool for steel).</li> <li>• Make sure the correct contact tip is used and it is not worn.</li> <li>• Make sure liner is the right size and type for wire.</li> <li>• Make sure the liner is not bent so that friction is caused between the liner and the wire.</li> </ul>
MIG (GMAW/FCAW) welding problems	<ul style="list-style-type: none"> <li>• Make sure the MIG torch is connected to correct polarity. Refer to the electrode wire manufacturer for the correct polarity.</li> <li>• Replace contact tip if it has arc marks in the bore causing excessive drag on the wire.</li> <li>• Make sure the correct shielding gas, gas flow, voltage, welding current, travel speed and MIG torch angle is used.</li> <li>• Make sure the work lead has proper contact with the work piece.</li> </ul>
MMA (SMAW) basic welding problems	<ul style="list-style-type: none"> <li>• Make sure you are using correct polarity. The electrode holder is usually connected to the positive polarity and the work lead to the negative polarity. If in doubt consult the electrode data sheet.</li> </ul>
TIG (GTAW) welding problems	<ul style="list-style-type: none"> <li>• Make sure the TIG torch lead is connected to negative welding terminal</li> <li>• Make sure the correct shielding gas, gas flow, voltage, welding current, travel speed, filler rod placement, electrode diameter and welding mode on power source is used.</li> <li>• Make sure the work clamp has proper contact with the work piece.</li> <li>• Make sure the gas valve on the TIG torch is on.</li> </ul>

<b>Type of fault</b>	<b>Corrective action</b>
No power/No arc	<ul style="list-style-type: none"><li>• Check that the input power supply switch is turned on.</li><li>• Check if a temperature fault is shown on display.</li><li>• Check if system breaker is tripped.</li><li>• Check that the input power, welding and return cables are correctly connected.</li><li>• Check that the correct current value is set.</li><li>• Check the input power supply fuses.</li></ul>
The overheating protection trips frequently.	<ul style="list-style-type: none"><li>• Make sure that you are not exceeding the recommended duty cycle for the weld current you are using. See section "Duty cycle" in the OPERATION chapter.</li><li>• Make sure the air inlets or outlets are not clogged.</li></ul>

## 9 ORDERING SPARE PARTS

---



### CAUTION!

Repair and electrical work should be performed by an authorised ESAB service technician. Use only ESAB original spare and wear parts.

The EMP 215ic and EM 215ic are designed and tested in accordance with international standards **IEC-/EN 60974-1, IEC-/EN 60974-5, IEC-/EN 60974-7, IEC-/EN 60974-10, IEC-/EN 60974-12** and **IEC-/EN 60974-13**. It is the obligation of the authorized service centre carrying out the service or repair work to ensure that the product still conforms to the aforementioned standards.

The spare parts list is published in a separate document that can be downloaded from the Internet: [www.esab.com](http://www.esab.com)

# DIAGRAM

EMP 215ic, EM 215ic

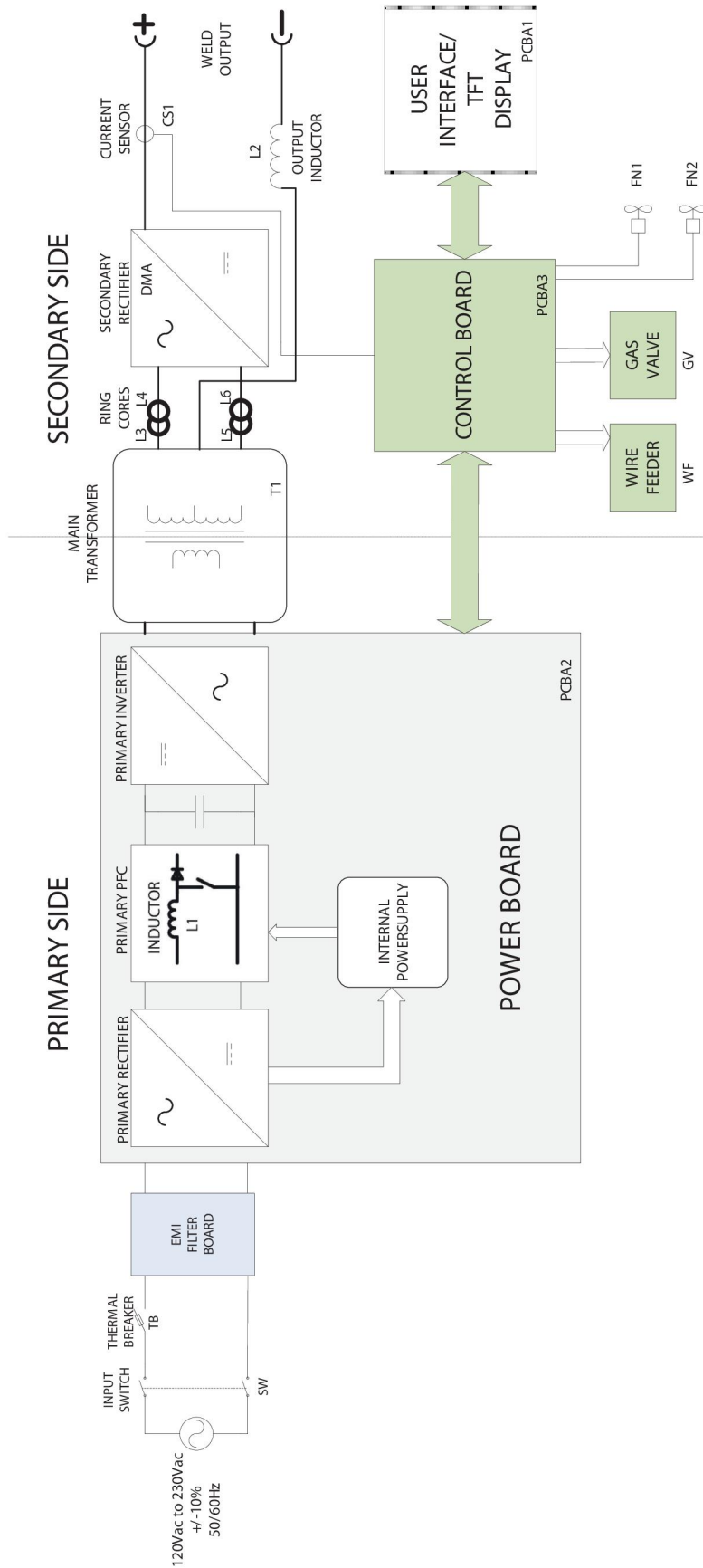

---

**ORDERING NUMBERS**

---

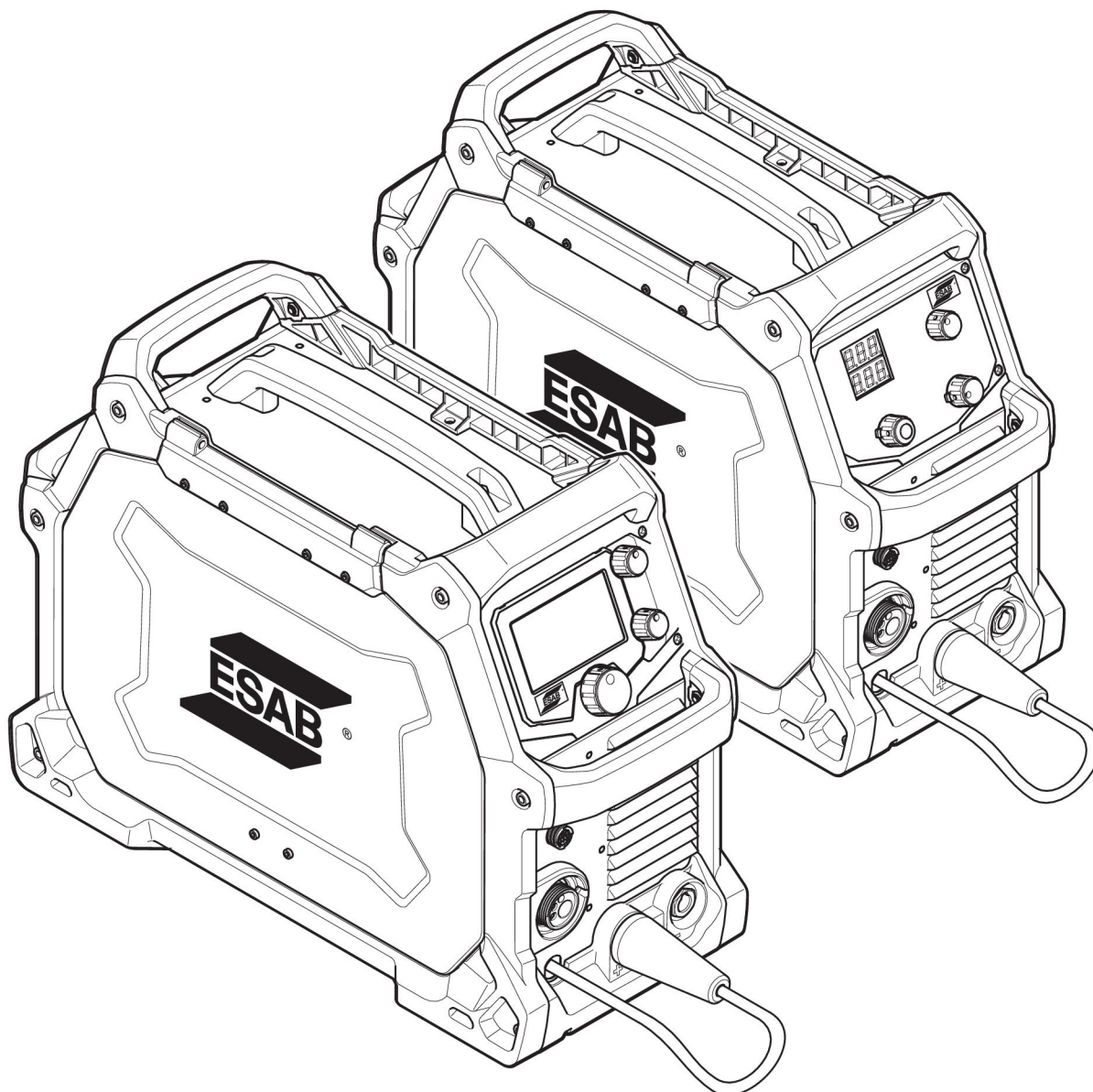

Ordering no.	Denomination	Note
0700 300 985	EMP 215ic	Bobbin Ø100–200 mm (4–8 in.) CE, euro connection
0700 300 986	EM 215ic	Bobbin Ø100–200 mm (4–8 in.) CE, euro connection
0463 412 001	Spare parts list	
0459 560 101	Instruction manual for MXL™ 200	

---

**WEAR PARTS**

---

Item	Ordering no.	Denomination	Wire type	Wire dimensions
1	0558 102 460	Wire outlet guide steel	Fe/SS/Flux Cored	1.0 mm – 1.2 mm (0.040 in. – 0.045 in.)
	0558 102 461	Wire outlet guide steel	Fe/SS/Flux Cored	0.6 mm – 0.8 mm (0.023 in. – 0.030 in.)
	0464 598 880	Wire outlet guide teflon	Aluminium	1.0 mm – 1.2 mm (0.040 in. – 0.045 in.)
2	0558 102 328	Wire inlet guide	Fe/SS/Flux Cored	0.6 mm / 0.8 mm / 0.9 mm / 1.2 mm (0.023 in. / 0.030 in. / 0.035 in. / 0.045 in.)
3	0191 496 114	Key-drive shaft crescent	N/A	N/A
4	0367 556 001	Feed roll "V" groove	Fe/SS/Flux Cored	0.6 mm / 0.8 mm (0.023 in. / 0.030 in.)
	0367 556 002	Feed roll "V" groove	Fe/SS/Flux Cored	0.8 mm / 1.0 mm (0.030 in. / 0.040 in.)
	0367 556 003	Feed roll "V" groove	Fe/SS/Flux Cored	1.0 mm / 1.2 mm (0.040 in. / 0.045 in.)
	0367 556 004	Feed roll "U" groove	Aluminium	1.0 mm / 1.2 mm (0.040 in. / 0.045 in.)
5	0558 102 329	Locking knob (Wire tension)	N/A	N/A
6	0558 102 518	Locking knob for the feed roll		
7	0558 102 331	Pressure arm complete assembly	N/A	N/A
8	0558 102 330	Screw	N/A	N/A
9	0558 102 459	Euro adapter locating screw	N/A	N/A

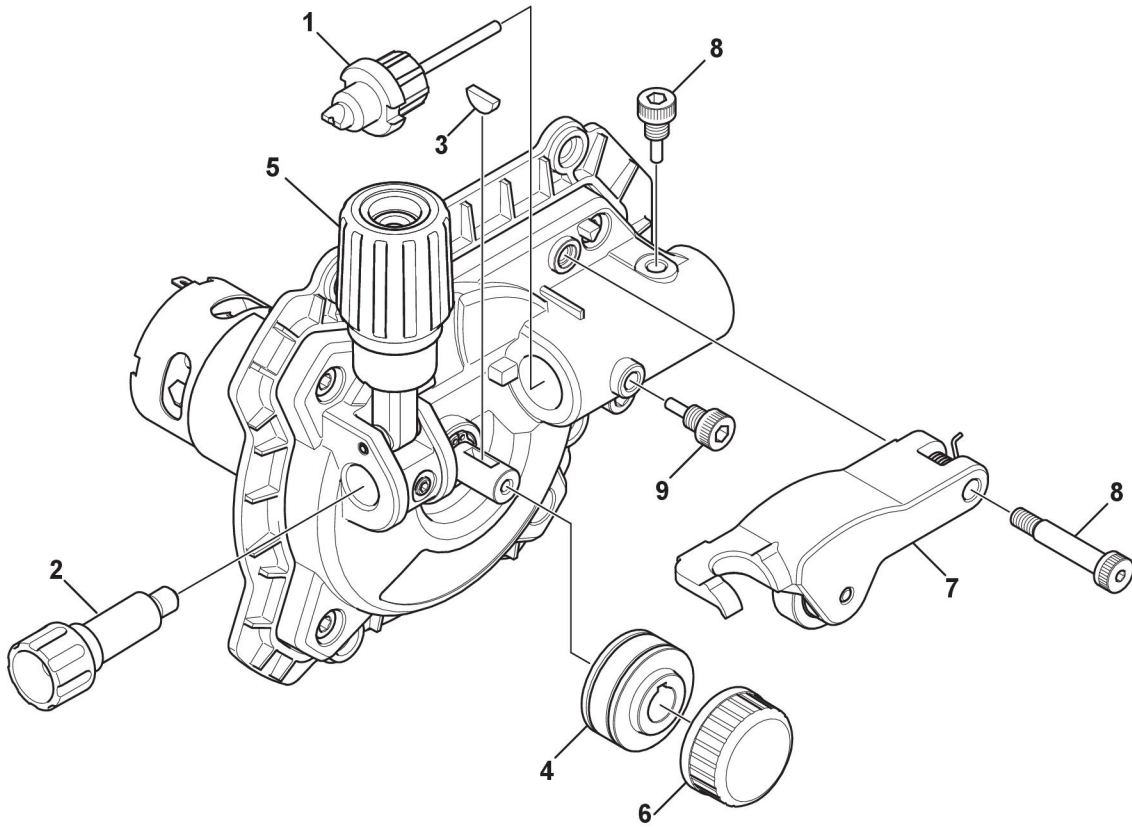

**ACCESSORIES**

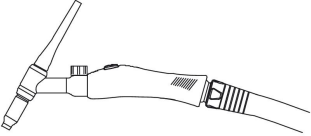
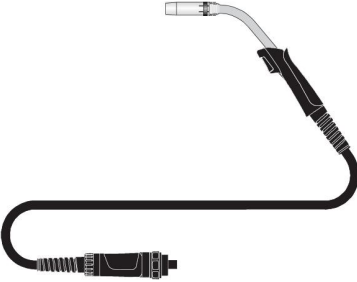
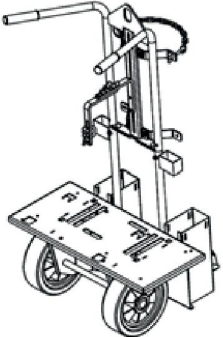
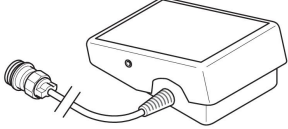
0700 300 869	<b>TIG Torch</b> ET 17V 4 m TIG torch c/w 8 pin plug	
0700 200 004	<b>MIG Torch</b> MXL™ 270 3 m (for FCW 1.2 mm)	
0700 300 872	<b>Trolley</b>	
W4014450	<b>Foot control</b> Contactor on/off and current control with 4.6 m (15 ft) cable and 8-pin male plug	



**REPLACEMENTS PARTS**

---

<b>Item</b>	<b>Ordering no.</b>	<b>Denomination</b>
1	0700 200 002	MIG Torch MXL™ 200, 3 m (10 ft)
3	0349 312 105	Gas hose, 4.5 m (14.8 ft)
4	0700 006 900	MMA welding cable kit, 3 m (10 ft)
5	0700 006 901	Return welding cable kit, 3 m (10 ft)



# A WORLD OF PRODUCTS AND SOLUTIONS.



For contact information visit [esab.com](http://esab.com)

ESAB AB, Lindholmsallén 9, Box 8004, 402 77 Gothenburg, Sweden, Phone +46 (0) 31 50 90 00

<http://manuals.esab.com>

